

LED Auxiliary Lights - Model 832

PRODUCT INFORMATION

Description	12-24V LED Auxiliary Light with Flood Beam Pattern
Height	154.94 mm / 6.1 in
Width	115.06 mm / 4.53 in
Depth	68.58 mm / 2.7 in
Shape	Square
Outer Lens Material	Polycarbonate
Outer Lens Color	Clear
Housing Material	Die-Cast Aluminum
Housing Color	Black
Mounting Hardware Description	(x1) 5/16"-18 x 0.58" Mounting Bolt
Mounting Type	Universal Pedestal Mount
Minimum Operating Temperature	-40 °C / -40 °F
Maximum Operating Temperature	65 °C / 149 °F
Connector or Wiring	Integrated 2-Pin Deutsch Weather-Proof Socket (DT04-2P)
Mating Connector	2-Pin Deutsch Weather-Proof Plug (DT06-2S)
Product Weight	1.82 lbs / 0.83 kgs
Shipping Weight	1.82 lbs / 0.83 kgs



Print date: 2024-08-11

© 2024 J.W. Speaker Corporation • Germantown, WI U.S.A.
www.jwspeaker.com • speaker@jwspeaker.com • 262.251.6660

J.W. SPEAKER 
Engineered. Lighting. Solutions.

LED Auxiliary Lights - Model 832

PRODUCT DIMENSIONS

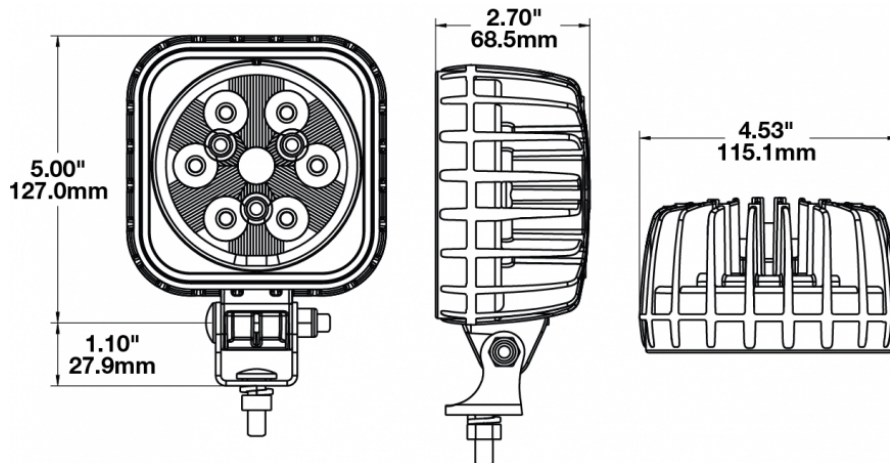

ELECTRICAL SPECIFICATIONS

Input Voltage	12-24V DC
Operating Voltage	10-32V DC
Red Wire	Positive
Black Wire	Negative
Current Draw	3.5A @ 12V DC 1.75A @ 24V DC

REGULATORY STANDARDS COMPLIANCE



Buy America Standards
IEC IP69K

Eco Friendly
UL Recognized

Print date: 2024-08-11

© 2024 J.W. Speaker Corporation • Germantown, WI U.S.A.
www.jwspeaker.com • speaker@jwspeaker.com • 262.251.6660

LED Auxiliary Lights - Model 832

PHOTOMETRIC SPECIFICATIONS

Raw Lumen Output	3,900
Effective Lumen Output	2,400
Nominal LED Color Temperature	5700 K
Beam Pattern(s)	Forward Lighting - Flood (Standard)

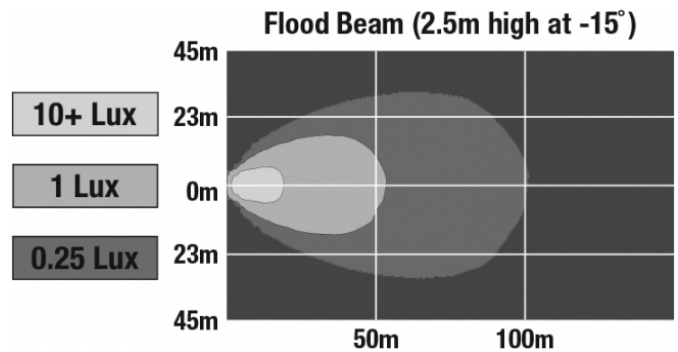

APPLICATIONS



PRODUCT WARNINGS

For California residents:

⚠️ **WARNING:** Cancer and reproductive harm - www.P65Warnings.ca.gov.

⚠️ **AVERTISSEMENT:** Cancer et effet nocif sur la reproduction - www.P65Warnings.ca.gov.

Print date: 2024-08-11

© 2024 J.W. Speaker Corporation • Germantown, WI U.S.A.
www.jwspeaker.com • speaker@jwspeaker.com • 262.251.6660

J.W. SPEAKER
 Engineered. Lighting. Solutions.

LED Auxiliary Lights - Model 832

ACCESSORIES



Part Number
8200491

Mounting Kit For Work
Lights

RELATED PRODUCTS



Part Number
1300161

12-24V LED Auxiliary
Light with Spot Beam
Pattern



Part Number
1300171

12-24V LED Auxiliary
Light with Trapezoid
Beam Pattern



Part Number
1300611

24V LED Auxiliary
Light with Trapezoid
Beam Pattern



Part Number
1300621

24V LED Auxiliary
Light with Flood Beam
Pattern